

META META SLIM Mitigeur monocommande de lavabo avec garniture d'écoulement - Laiton brossé (Or 23cts)















META

33 501 662



- saillie 125 mm
- bec déverseur fixe
- jet circulaire enrichi en air
- hauteur de robinetterie 134 mm
- hauteur jusqu'au mousseur 52 mm
- diamètre de percement 35 mm
- 2x flexible de pression M 8 x 1 vissé, étanchéité contrôlée
- débit maxi. 5,7 l/min
- sans plomb
- Ce produit contribue au respect des exigences des systèmes d'évaluation des bâtiments écologiques, par exemple LEED®, BREEAM®, DGNB

Convient uniquement à un lavabo avec trop-plein.

	Laiton brossé (Or 23cts)	33 501 662-28
	Chrome	33 501 662-00
	Platine brossé	33 501 662-06
	Platine	33 501 662-08
	Dark Chrome	33 501 662-19
	Or clair	33 501 662-26
	Or clair brossé	33 501 662-27
	Rouge	33 501 662-29
	Orange	33 501 662-30
	Vert foncé	33 501 662-31
	Noir mat	33 501 662-33
	Bronze brossé	33 501 662-42
	Champagne brossé (Or 22cts)	33 501 662-46
	Champagne (Or 22cts)	33 501 662-47
	Chrome brossé	33 501 662-93
	Dark Platinum brossé	33 501 662-99

33 501 662
mm [inches]



Diagramme de débit



Certificats

LGA_29706.

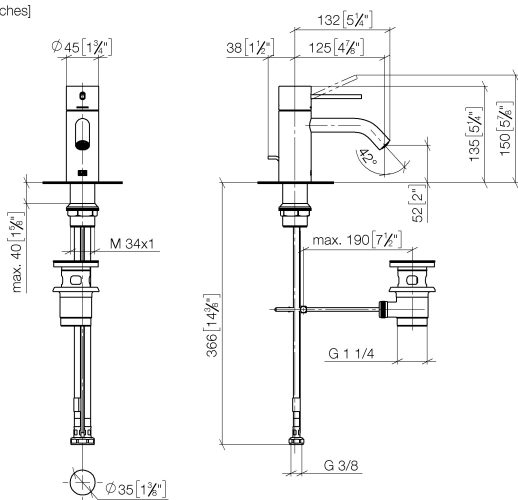
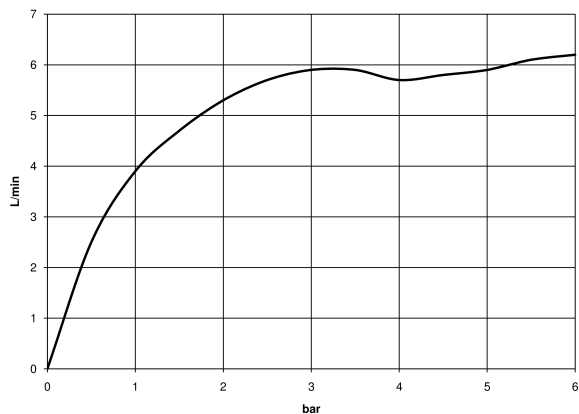
WRAS_2003051.

33 501 662

Les pièces pour les autres finitions peuvent être trouvées ici : [Chrome](#)

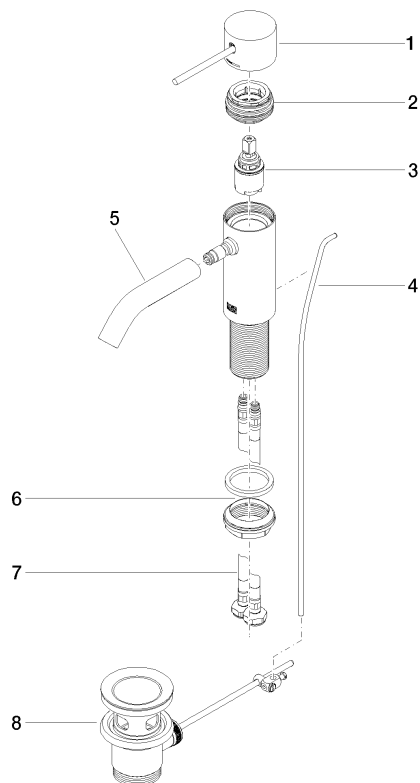

Liste des pièces de rechange

N°	Article Numéro	Désignation	Fréquence de montage	Délai de livraison
1	90 20 66 020 00-28	poignée	1	20
2	90 24 04 536 00 90	joint américain	1	60
3	90 15 05 044 00 90	cartouche	1	2
4	09 31 09 110-28	tige	1	20
5	90 11 06 206 00-28	bec déverseur	1	20
6	04 23 10 044 07 90	set de fixation	1	2
7	04 30 04 100 00 90	flexible	2	2
8	90 11 01 001 00-28	garniture d'écoulement	1	20